

ORIVENT 41L

Rooflight NSHEV



YOUR ONE-STOP SOLUTION FOR SMOKE EXTRACTION AND TO HEALTHY DAYLIGHT

Orivent 41L is an innovative rooflight NSHEV designed for versatile use in a variety of building applications. Its excellent smoke extraction function and efficient daily ventilation make it an ideal solution for many types of projects, not forgetting bright daylight to improve efficiency in your business.

THE SAFE AND RELIABLE CHOICE

Orivent 41L is a safe and reliable rooflight NSHEV with high-quality materials and construction ensuring a long lifespan and easy operation. Safety is a top priority in its design which helps you to extract smoke cost-effectively.





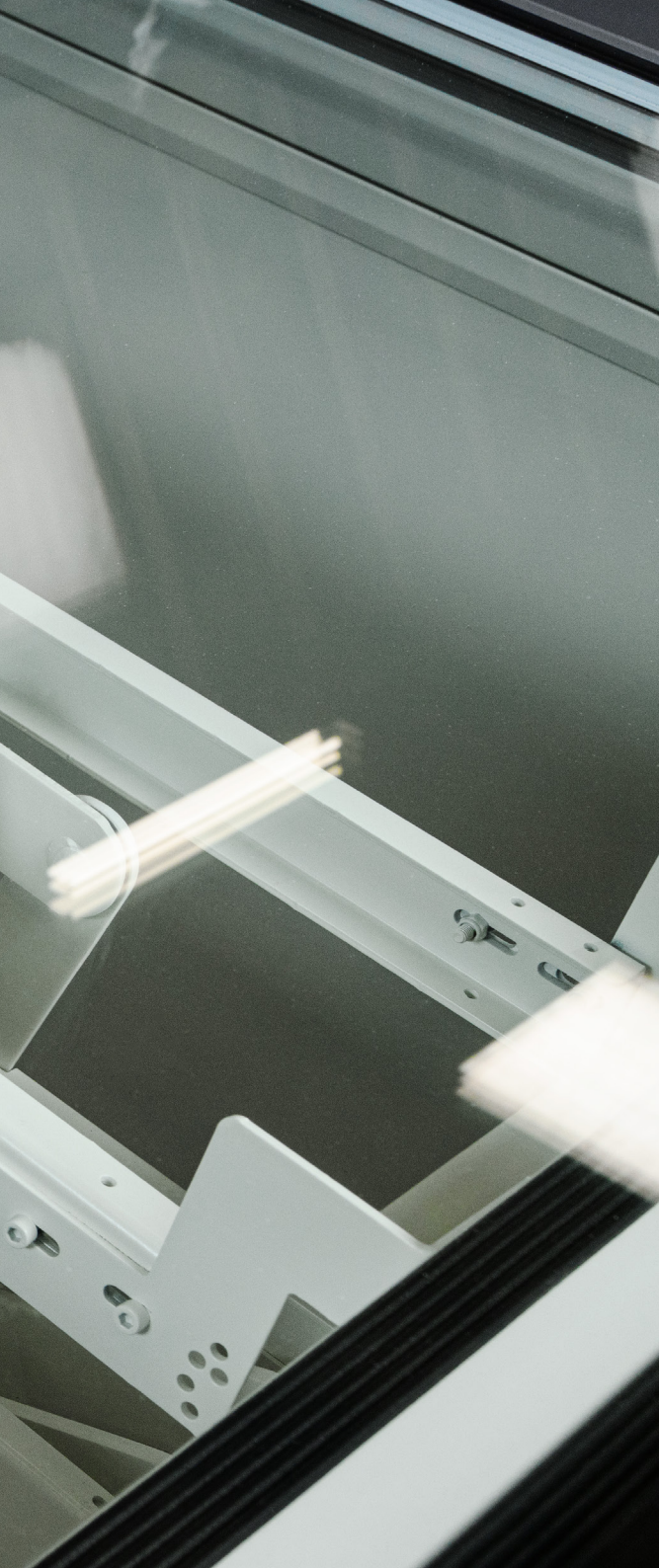

ENJOY FRESH AIR AND IMPROVED ENERGY EFFICIENCY

Orivent 41L's daily ventilation function improves indoor air quality and helps to cool down the indoor air during the summertime. It also provides an opportunity to save energy by the high insulation properties and reducing the need for powered ventilation systems and electric lighting.

DISCOVER THE CONVENIENCE OF ORIVENT 41L

Easy operation and installation make Orivent 41L an excellent option for both new buildings and renovation projects. Its capability to bring the daylight in and its quiet motor operation keeps the convenience in a high level both in office buildings and also in demanding precision production, not forgetting the advantage of business in commerce.

EXPERIENCE COMFORT AND SAFETY

- 1** Orivent 41L runs with **single actuator** even in biggest nominal size of 1200x2400 mm with a snow load rate of 800 N/m².
- 2** **Flashing protects the membrane** from the scorching sun, preventing the adhesive from deteriorating during the pleasant summer weather. Additionally, it effectively guides rainwater out of the vertical membrane.
- 3** **Optionally available 230 VAC limit switch** for indicating to building control system that the lid is closed.
- 4** **From the option list** you can select burglar bar (Ø12 mm steel bar) or safety net (Ø6 mm steel bar).

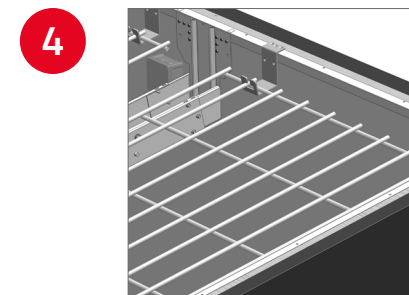
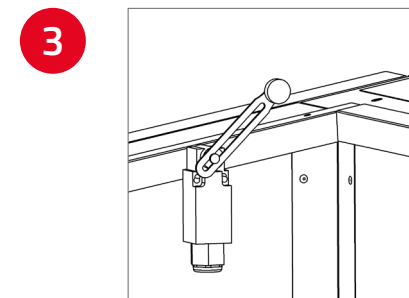
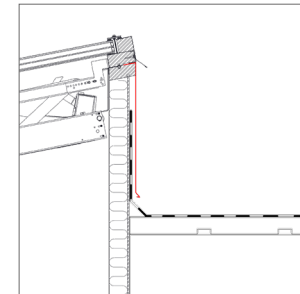
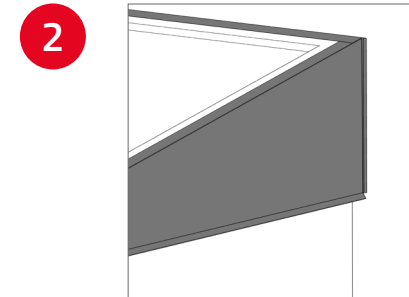

MODERN TECHNOLOGY

Even though it is said The Romans were the first known people to use glass for windows, we can still improve features of rooflights. In Orivent 41L glass is designed to hold high snow loads in Nordic countries while it has a great feature in keeping our buildings warm during the cold winter and cool when the Sun is shining but we still want to have sunlight in our working environment.

Orivent 41L not only allows people to safely exit in case of a fire but also lets fresh air in. This is why we call the Orivent 41L a true health and safety product.

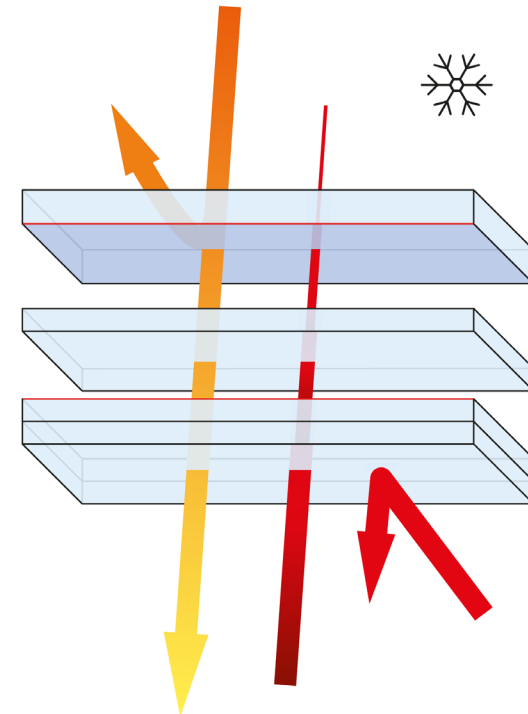

AVAILABLE IN MULTIPLE DIMENSIONS

As a customer-oriented family-owned company, Kera and its subsidiaries want to give our customers wide range of nominal sizes, upstand heights, interior colors, and also exterior colors. We want to give you an option to choose from width of 900 mm, 1000 mm and 1200 mm and the length starting from 900 mm up to 2400 mm, all with just one revolutionary opening system.

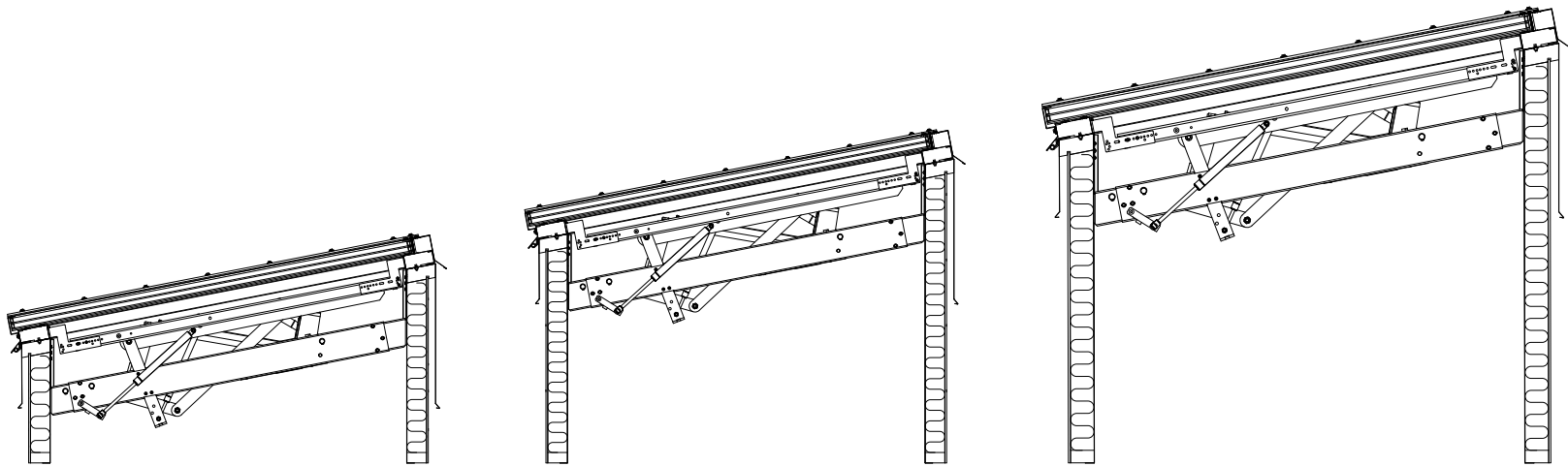



CONTACT OUR EXPERTS TO LEARN MORE

Our experts are available to provide further information on Orivent 41L. With their extensive knowledge and experience, they can help you choose the right accessories and configurations to ensure maximum comfort, safety, and energy efficiency, and take your property's comfort to a whole new level.



Bjerrevej 138
8700 Horsens, Danmark



optilite@optilite.dk



75 64 82 00



www.optilite.dk